



# TOF KHKT001-Evaluation Module (EVM) Hardware Guide

(For Qualcomm's RB5 Robotics Platform)



4<sup>th</sup> Apr. 2023

Ver 1.0



## **Notification about the transfer of the semiconductor business**

The semiconductor business of Panasonic Corporation was transferred on September 1, 2020 to Nuvoton Technology Corporation (hereinafter referred to as "Nuvoton"). Accordingly, Panasonic Semiconductor Solutions Co., Ltd. came under the umbrella of the Nuvoton Group, with the new name of Nuvoton Technology Corporation Japan (hereinafter referred to as "NTCJ").

In accordance with this transfer, semiconductor products were handled as NTCJ-made products after September 1, 2020.

Publisher of this Document is NTCJ.

**Nuvoton Technology Corporation Japan**

- **Introduction**
- **TOF Module – Overview**
  - Specifications
  - Block Diagram
  - Dimension of KHKT001-EVM
- **Connection Image of TOF camera**
  - Connection to Qualcomm's RB5 Mezzanine Board
  - Pin assignment of Adapter Board for KHKT001-EVM side and SoC side
  - Schematic and Circuit Diagram for Adapter Board
- **Principle of Time of Flight**
- **Depth Measurement Guidelines**
  - Multi-path Interference
  - Optical Scattering
  - Example of Evaluation Equipment
- **Examples of Depth Evaluation Results**
- **Depth Uniformity**
- **Safety instructions**

## ■ KHKT001 Module – General Introduction

\*For outdoor evaluation it is recommended to use module with 940/945nm configuration

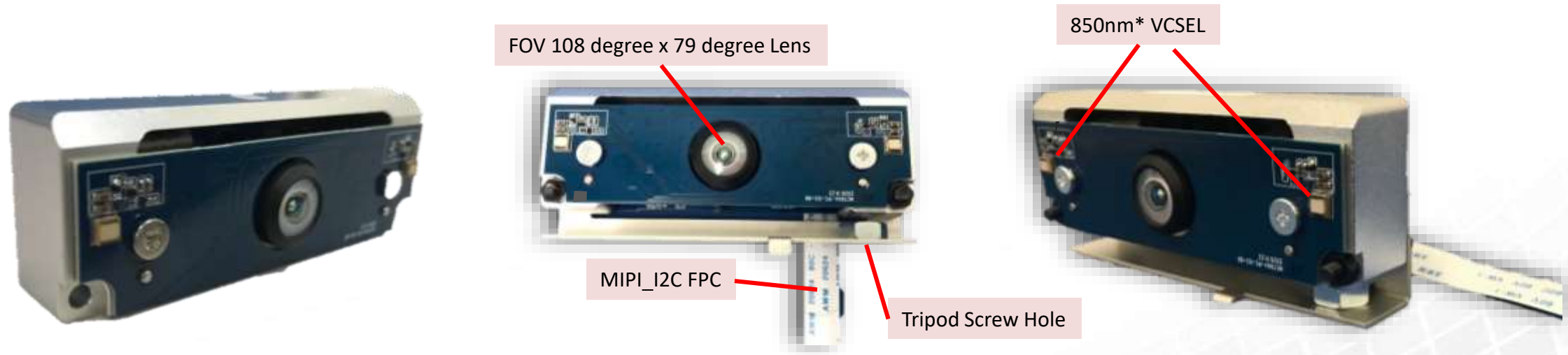

**\* The visual appearance of the module may change due to different module suppliers**

The KHKT001-EVM is a state-of-the-art 3D camera module that utilizes the VGA ToF sensor P/N KM34906 from Nuvoton. It is ideal for creating 3D sensing solutions for short to middle range applications. With a small form-factor and light weight, it can be seamlessly integrated to robotics platforms targeted for consumer and industrial segments.

This EVM can achieve upto 1% depth error and around 1% depth variation (standard deviation) of depth sensing from 0.2 m to 4.5 m range and provides depth, IR and background signals at pixels. The EVM uses wide FOV lens with low optical scattering, providing a 40% increase in FOV compared to the earlier ToF module V4T-EVM. This enables a reduction in blind spots in robot vision.

The KHKT001 complements the RB5 platform to provide an ideal 3D sensing solution. It serves as a reference design for the development of commercial 3D camera products, which facilitates the rapid creation of next-generation robots.

# Overview of KHKT001-EVM

## ■ Specifications

Parameter		KHKT001 – for in-door use*	
TOF Sensor		1/4" VGA /IR – TOF	
Resolution		640 x 480 (VGA)	
Lens	FOV	H: 110° x V: 80°	
	Aperture	F1.3	
VCSEL		850nm x 2pc	
Performance		<b>Mode 0: Short range</b>	<b>Mode 1: Long range</b>
	Camera Distance	0.2 to 1.2 [m]	0.5 to 4.5 [m]
	Frame Rate	30 fps	20 fps
Interface		MIPI (CSI-2) / I2C	
Module Size		85 x 29.4 x 22.9 [mm]	
Supply Voltage		DC 5V (From 4.85V to 5.3V)	
Operating Temperature		Ta= 0 to +60°C	

## ■ Block Diagram

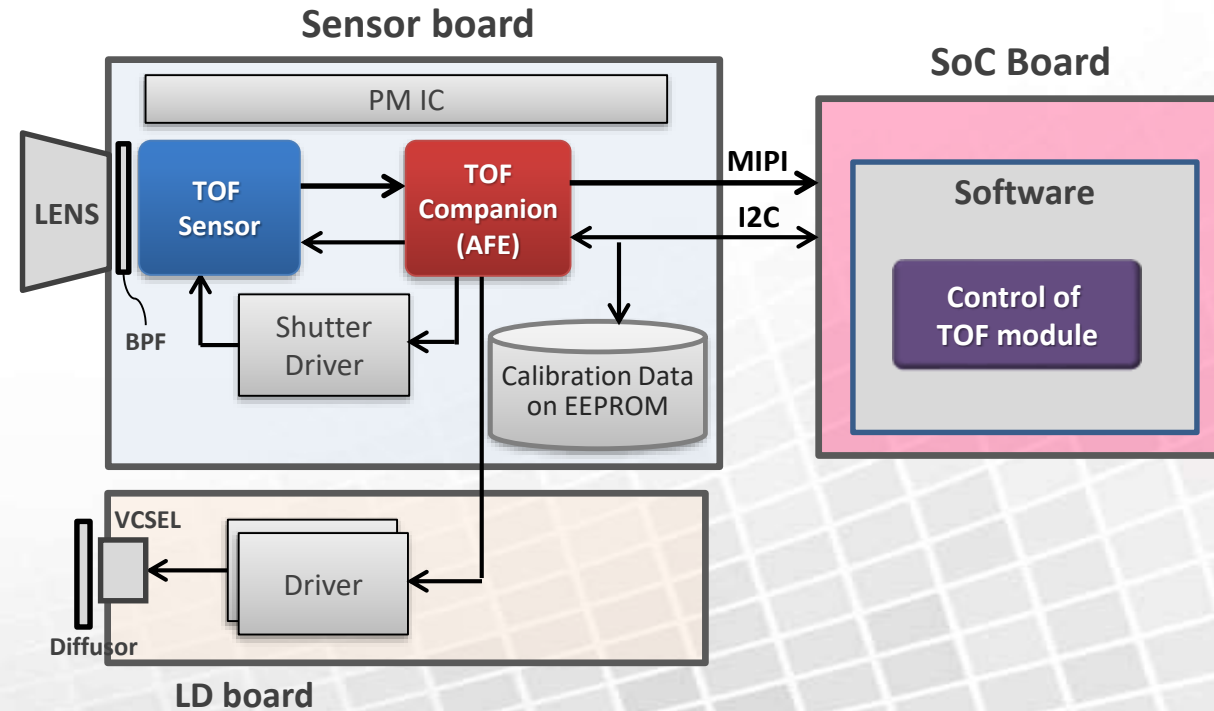



# Dimension of KHKT001-EVM

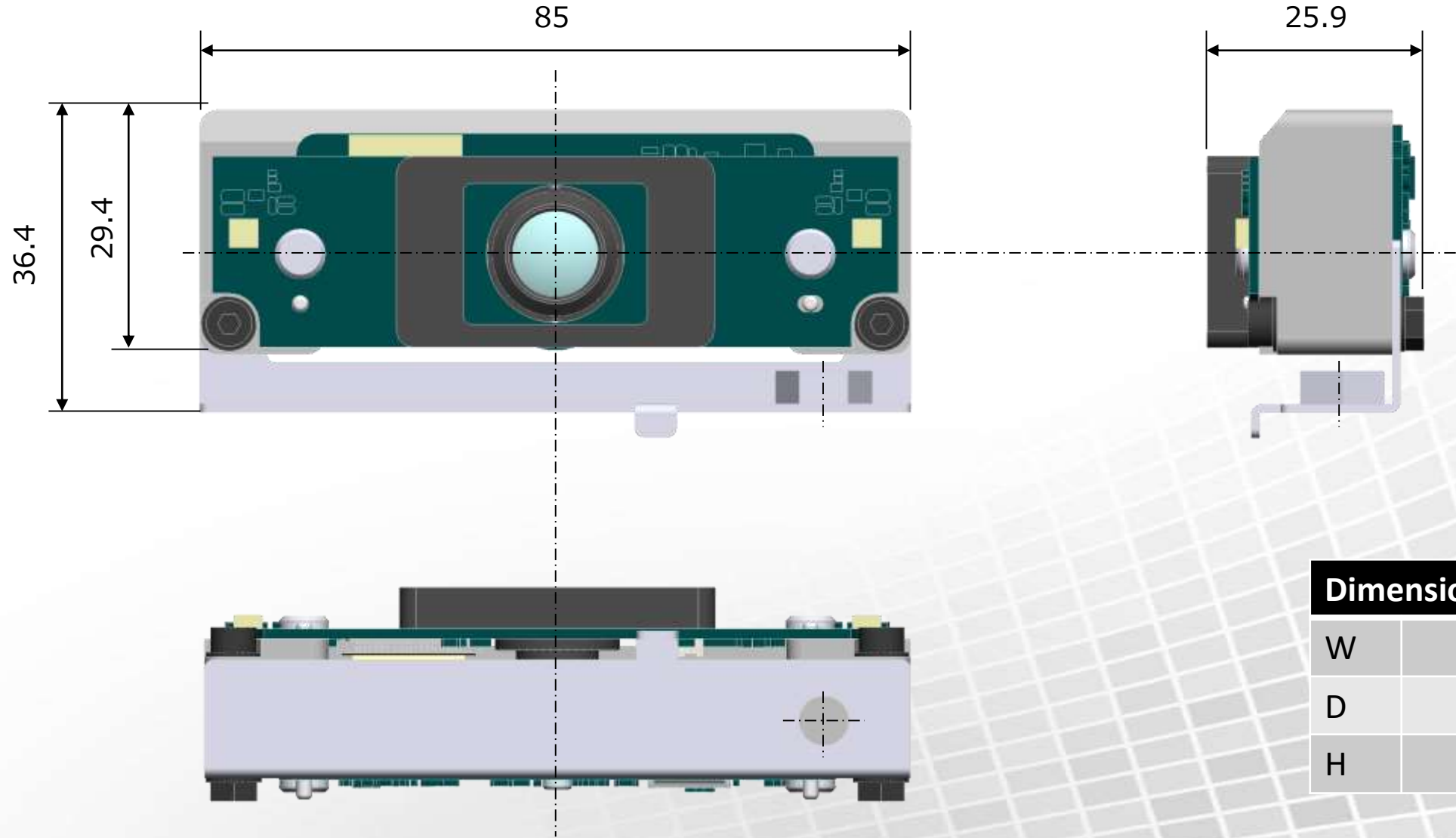

Dimension (mm)	
W	85
D	25.9
H	36.4

**\* The visual appearance/size of the module may change due to different module suppliers**

# Connection Image of TOF camera

**<Front image >**  
of TOF camera mounted



**<Rear image >**  
of TOF camera mounted

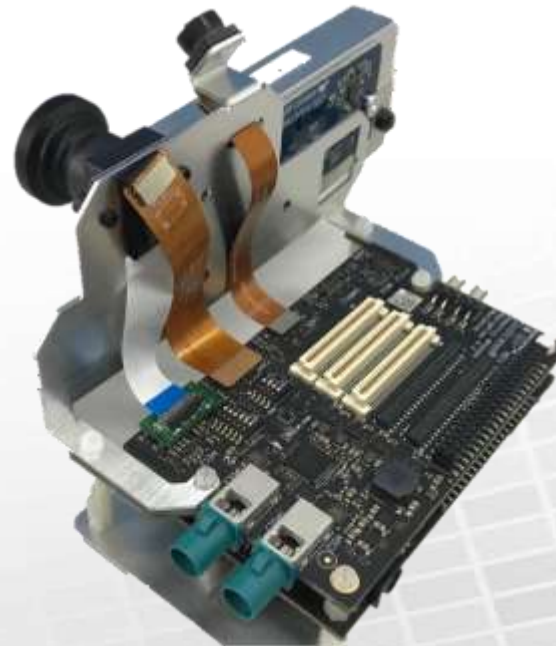

**<Connection image >**  
of TOF camera connected to RB5T

**Mezzanine board for RB5**

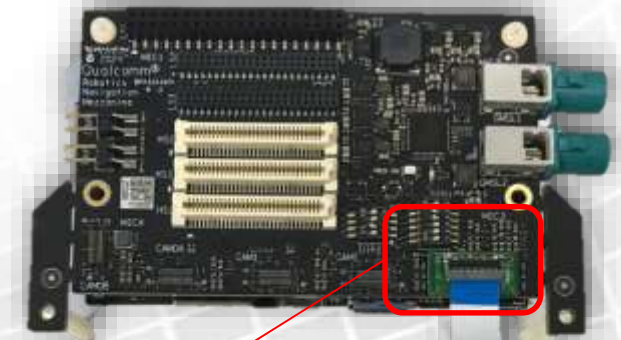

Connect TOF camera to RB5  
with FFC and adapter board

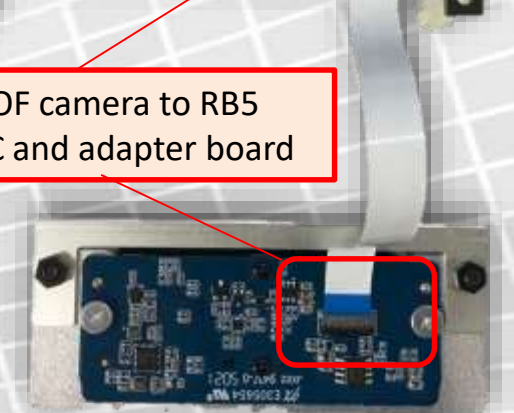

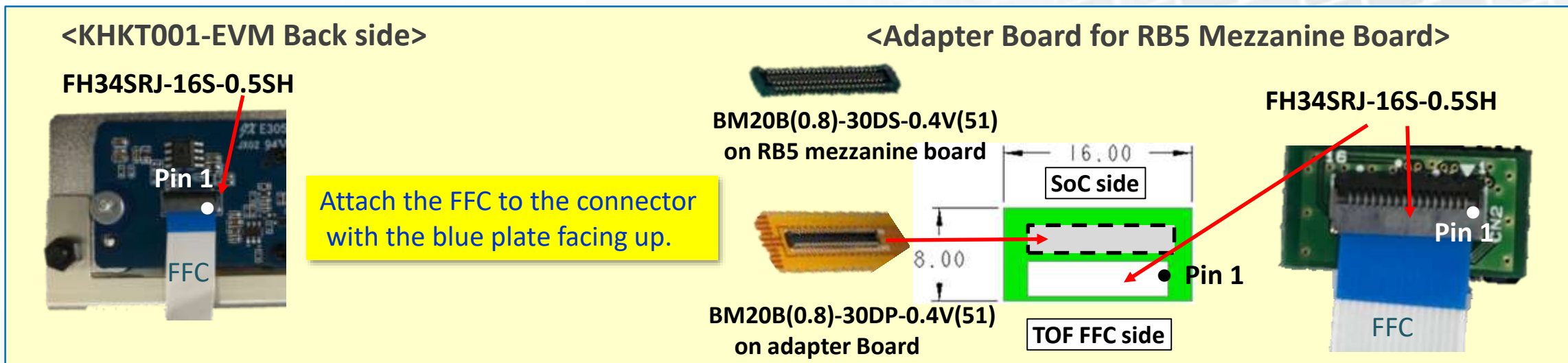
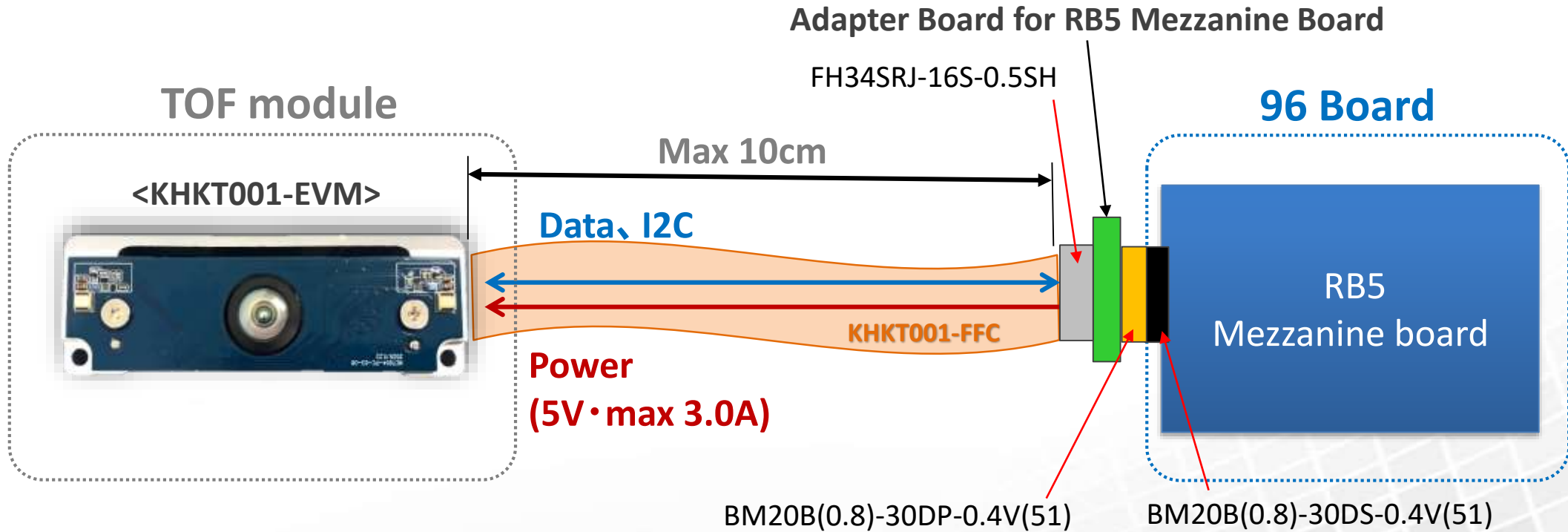

**KHKT001-EVM for RB5**

# Connection to Qualcomm's RB5 Mezzanine Board





# Pin assignment of Adapter Board for KHKT001-EVM side and SoC side

Pin# SoC side	Pin# ToF side	Pin Name	Function	Remark
21 	1 	CLKP	MIPI Clock	MIPI clock input of positive
20	2	CLKN	MIPI Clock	MIPI clock input of negative
10	3	DATA0P	MIPI data0	MIPI data input of positive for lane#0
11	4	DATA0N	MIPI data0	MIPI data input of negative for lane#0
18	5	DATA1P	MIPI data1	MIPI data input of positive for lane#1
17	6	DATA1N	MIPI data1	MIPI data input of negative for lane #1
25	7	I2C_SCL	I2C_SCL	Should be connected to I2C clock output terminal on SoC
26	8	I2C_SDA	I2C_SDA	Should be connected to I2C data terminal on SoC
5	9	RSTB_SYNC	RESET / SYNC	Static output control
27	10	AFE_GPO5	Field Index	Should be connected to EX-IRQ input terminal for both edge on SoC
GND 6, 9, 12, 15, 19, 22, 24,	11	GND	GND	Connect to DC jack – and GND connection pin for SoM board
	12	GND	GND	Connect to DC jack – and GND connection pin for SoM board
	13	GND	GND	Connect to DC jack – and GND connection pin for SoM board
VCC 3, 28, 30 + 16* *need 5V input	14	VCC	Power supply input	Connect to DC jack or QCOM board Power Supply (5V•max 3.0A)
	15	VCC	Power supply input	Connect to DC jack or QCOM board Power Supply (5V•max 3.0A)
	16	VCC	Power supply input	Connect to DC jack or QCOM board Power Supply (5V•max 3.0A)

# Schematic and Circuit Diagram for Adapter Board

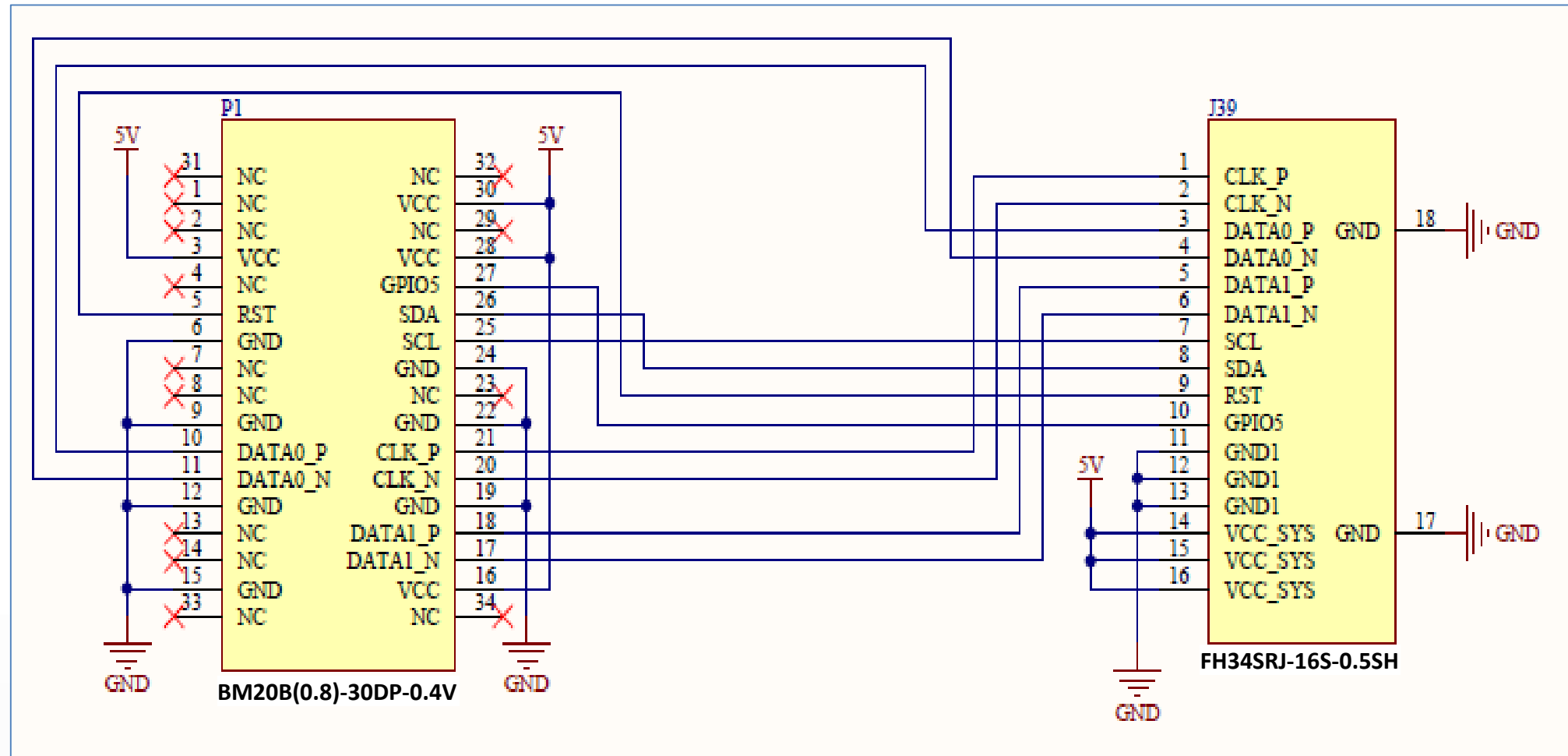

Circuit Diagram of Adapter Board for ToF Module

# Principle of Time of Flight

The distance measuring principle for KHKT001-EVM is based on the Time of Flight concept as shown in the figure below:

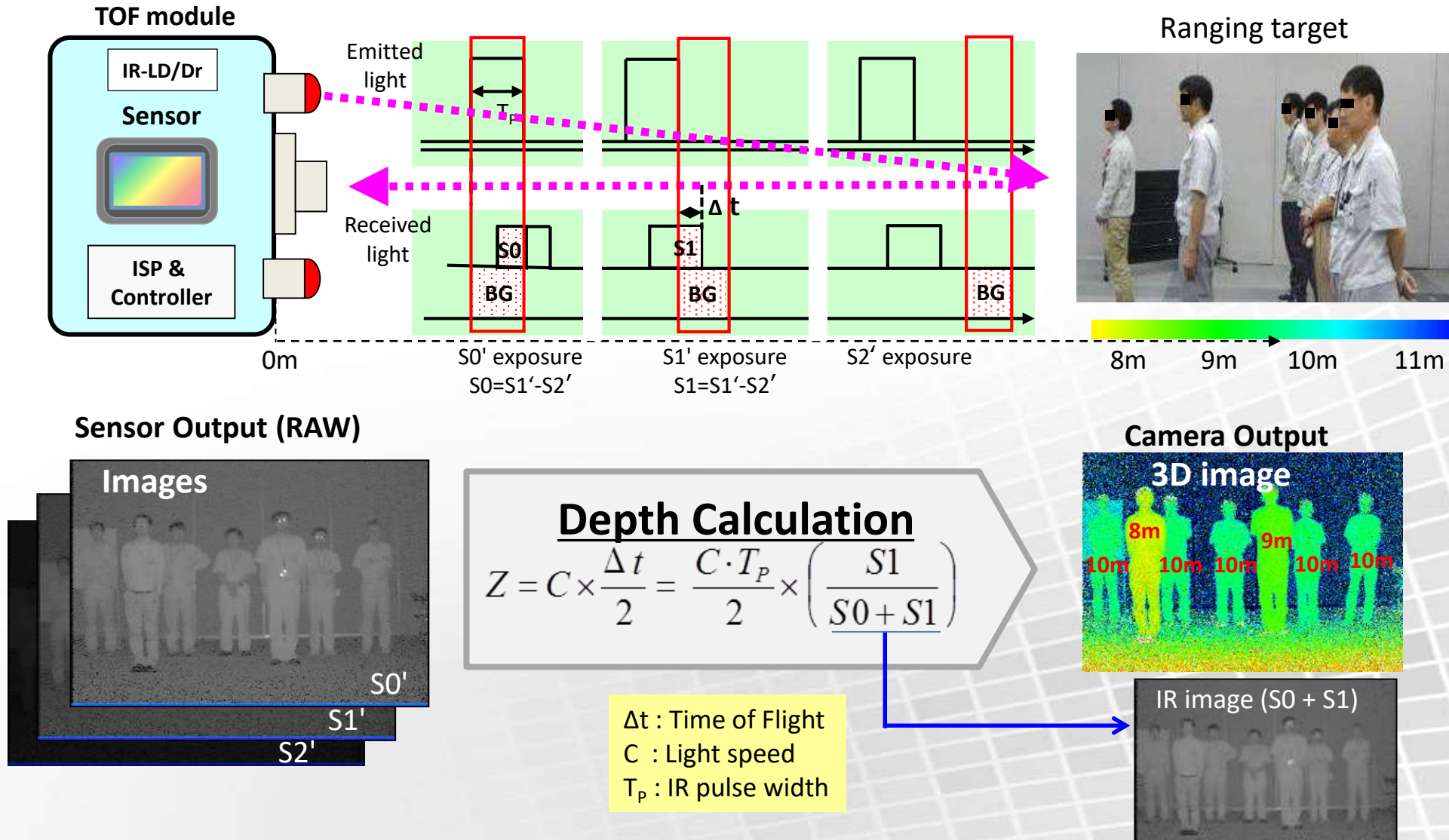

# Depth Measurement Guidelines

## Reference Plane:

- The front edge of module has been used as the reference plane for calibration of KHKT001-EVM, so all measurements taken by KHKT001-EVM are values of distance (in mm) from this front edge.

Refer to the figure below:

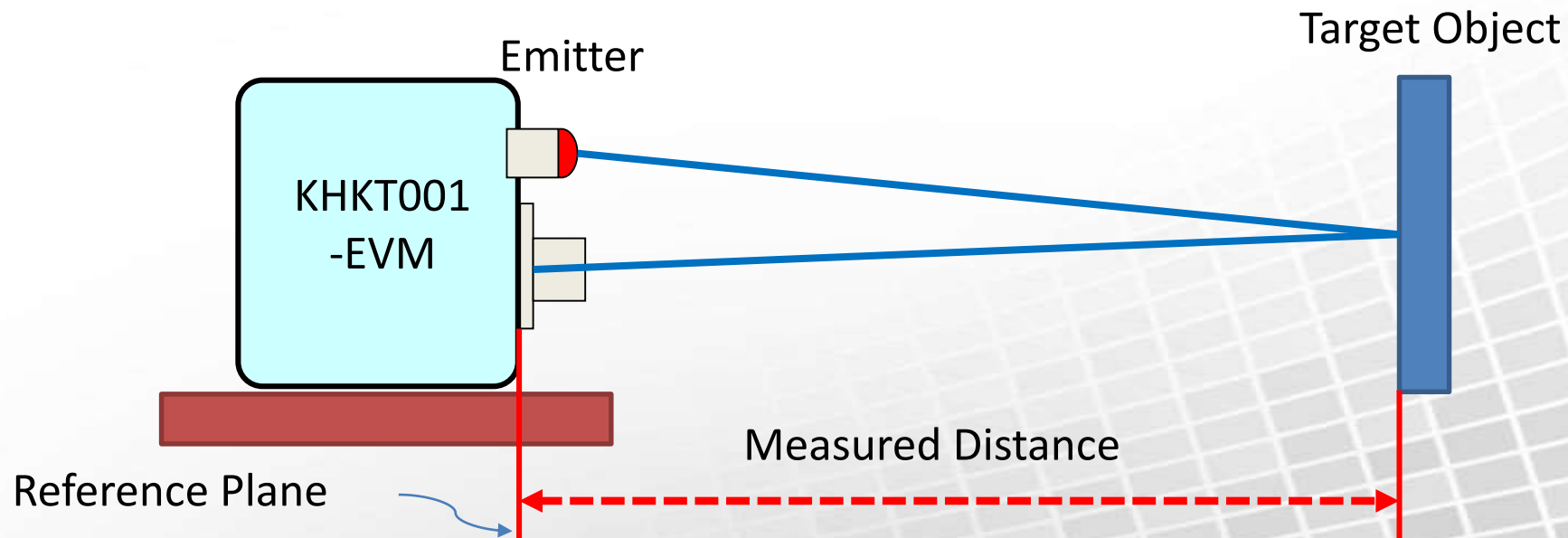



# Multipath Interference

## 1) Example of Multipath Interference

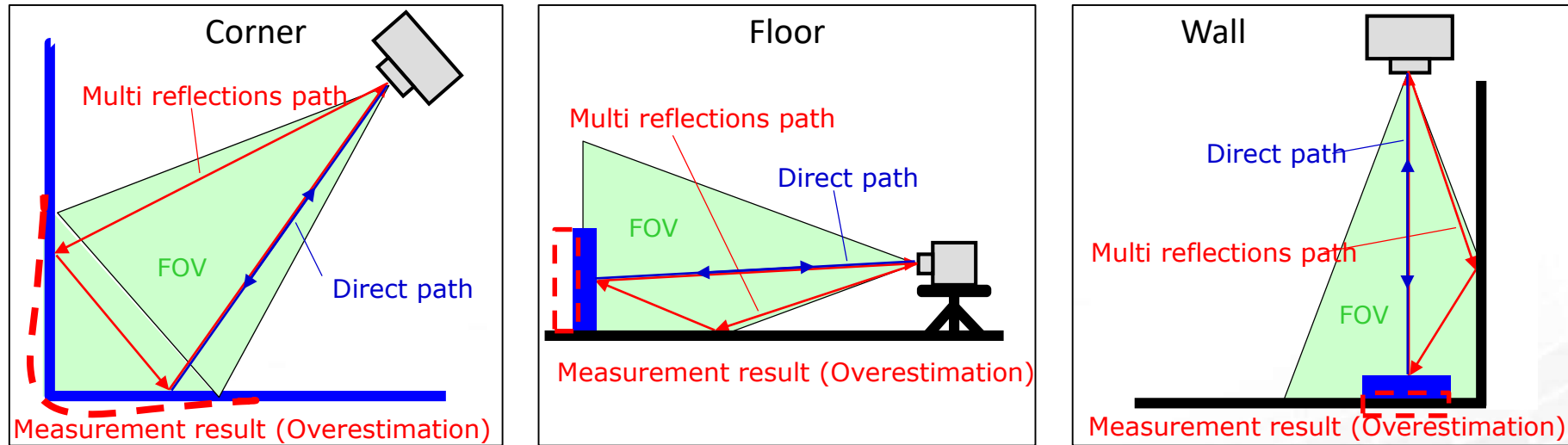

## 2) Dependency on surface condition of the measured object

Influence level of the multi-path reflection depends on not only the reflectance of the multi-path objects and measured object but also the surface condition of the measured object.

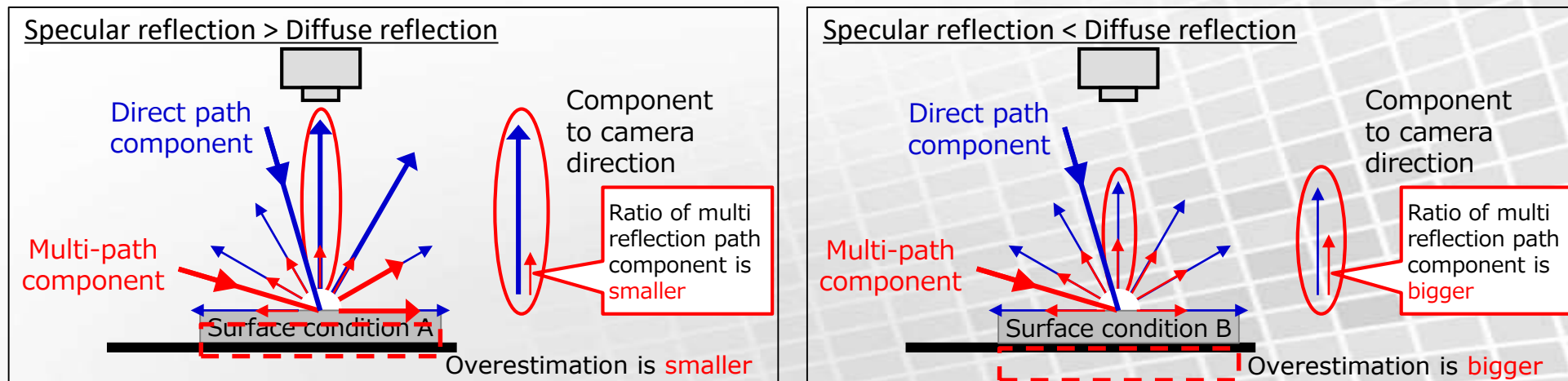

# Optical Scattering

Optical scattering occurs due to unwanted reflections within the optics. This cannot be eliminated completely but improvements have been achieved in KHKT001-EVM using advanced lens design.

In order to avoid scattered light issue as much as possible, KHKT001-EVM should be placed at the greatest distance possible from disturbing object from which light might be reflected.

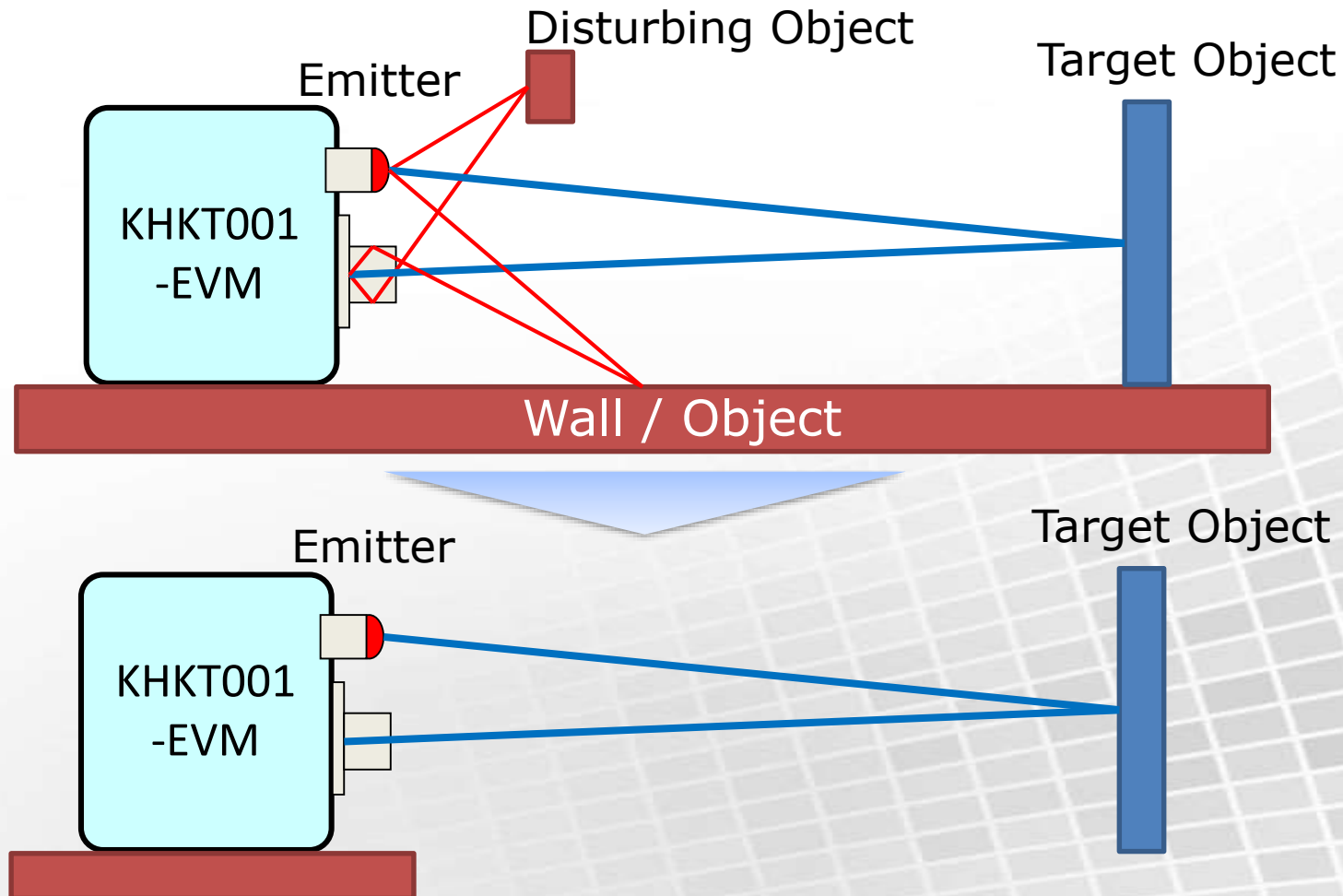

# Example of Evaluation Equipment

## Evaluation equipment

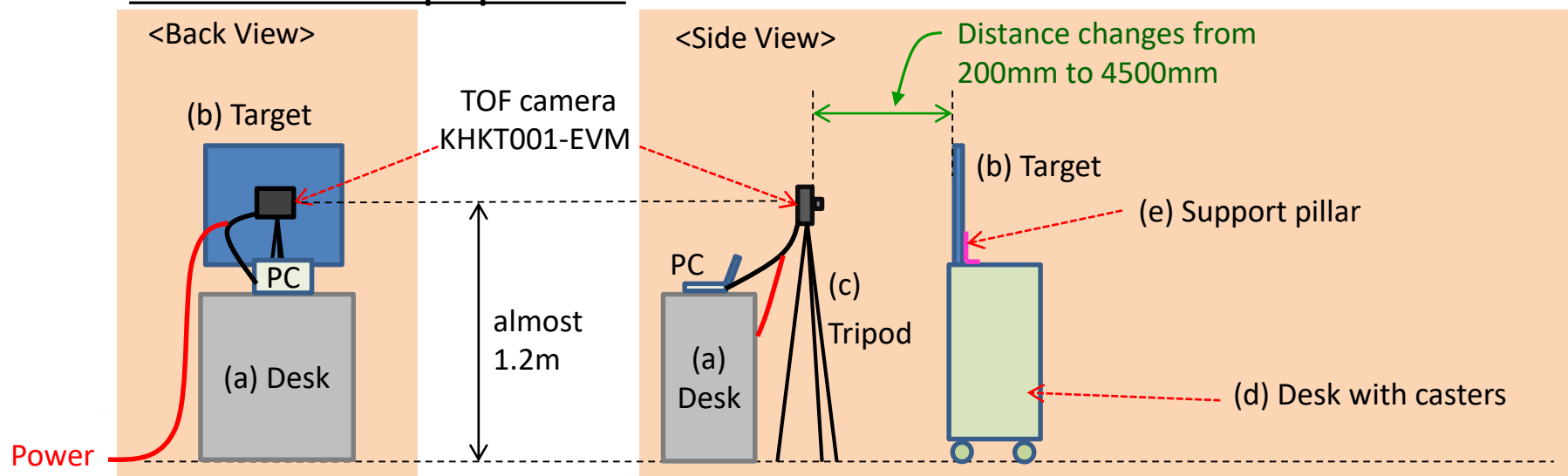

No	Items	Detail specs
(a)	Desk	Normal PC desk.
(b)	Target	- Flat, thin and durable board - Target size is 60 cm (H) x 50 cm(V) - Reflectivity is 90%@850 nm light
(c)	Tripod for camera	Height should be adjusted to around 1.2m.
(d)	Desk with caster	Desk with casters is useful to change the distance between the target and the TOF camera.
(e)	Support pillar	Book stand etc.

# Examples of Depth Evaluation Results

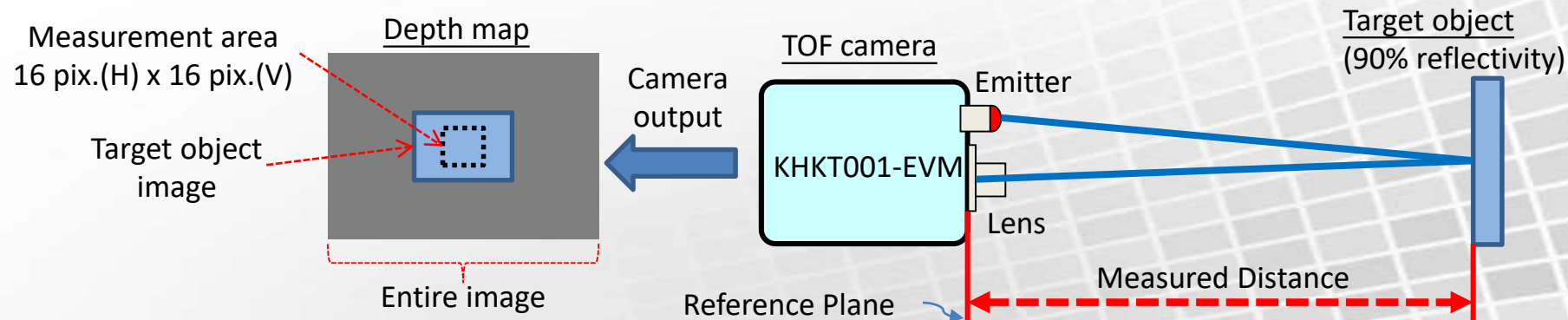
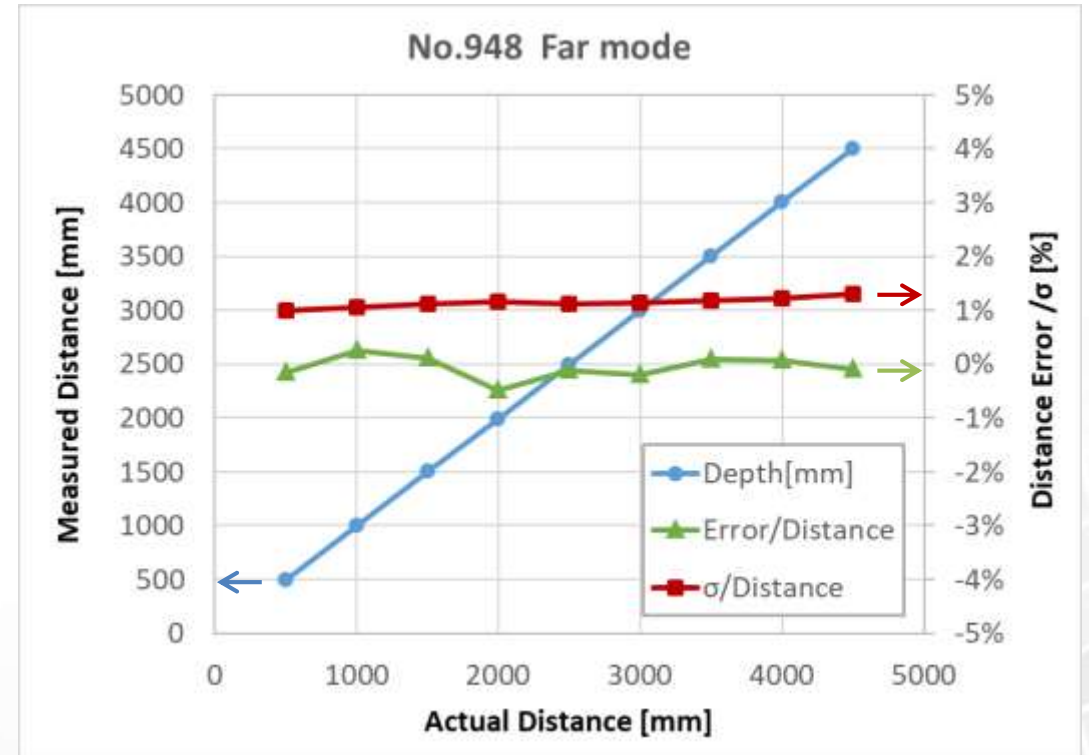
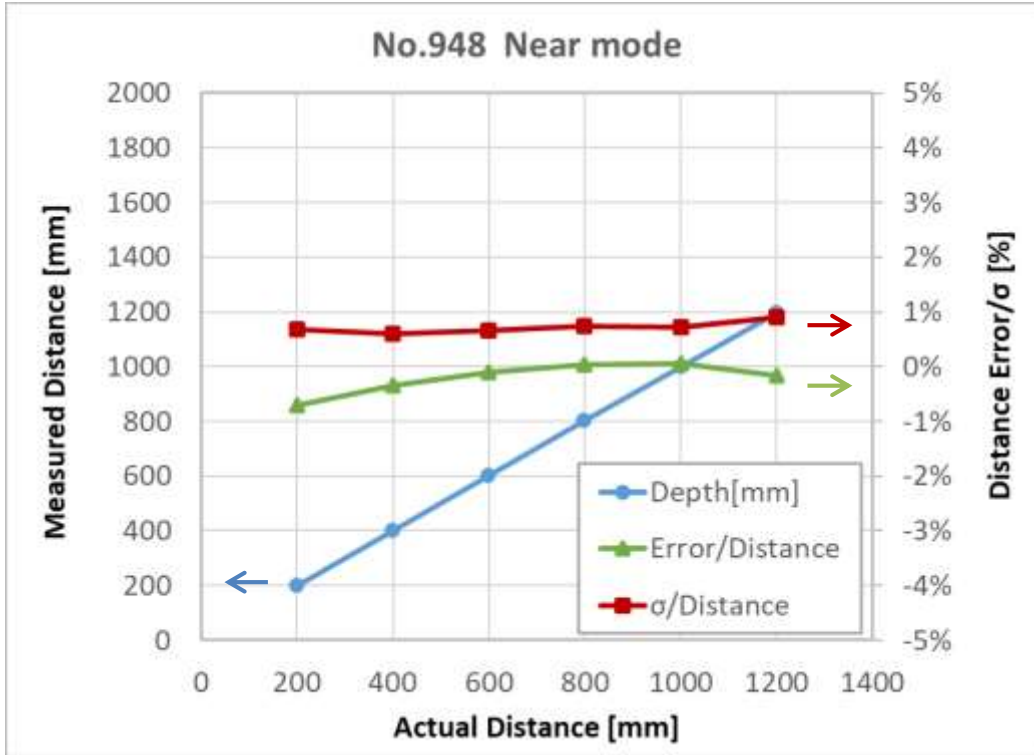



## Corners of depth map has large depth error

### [Phenomena]

Due to small mismatch between lens FOV and diffuser FOI of light source in the current TOF module, depth at image corners are prone to have large error as shown in the following depth map example.

Please be aware this characteristics when using the current ToF module.

### [Example of Depth Map]

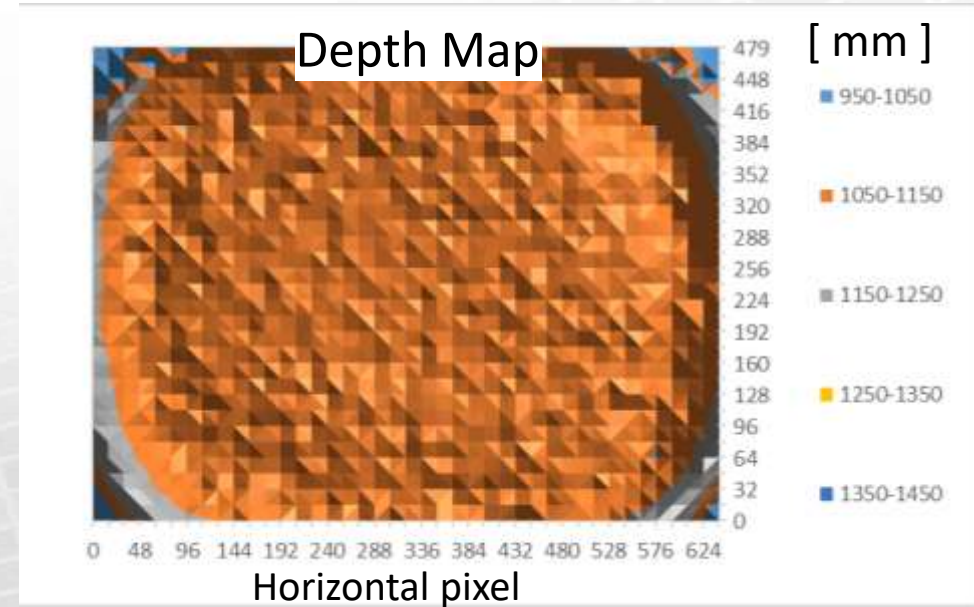
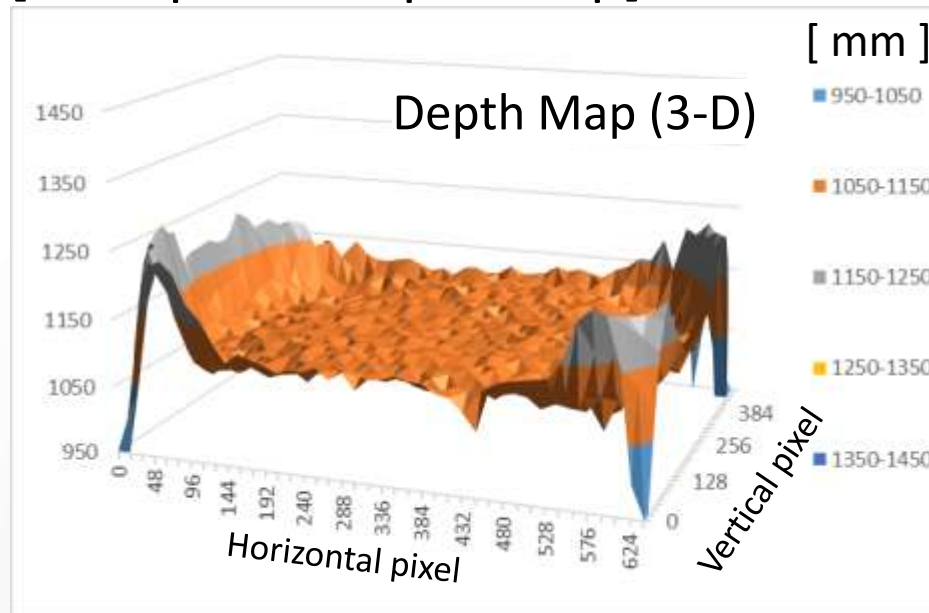

# Safety Instructions

Please observe the following condition for the safety operation of KHKT001-EVM.

In case of module usage other than stated, any claims will be rendered void.

- In any case, it is **not** allowed to disassemble KHKT001-EVM or to make any changes to the hardware.
- Only the power supply provided by Thundercomm's 96-board is allowed to be used with the camera.  
**Do not use other power supply.**
- KHKT001-EVM is **not** waterproof and dustproof. Do **not** use under rain.
- Do **not** apply any register settings and EEPROM values in KHKT001-EVM (especially laser emission settings)
- Handle with care for KHKT001-EVM or power supply connector.
- Do **not** touch Diffuser or Lens.
- KHKT001-EVM uses VCSELs (laser diode technology). Before starting the ToF module, ensure by visual inspection that VCSEL's Diffuser has **not** fallen off OR do not have any **cracks/breakage**.
- KHKT001-EVM is **not** certified for any safety related applications.

# Record of Changes

Date	Ver	Description	Remarks
Apr. 4, 2023	1.0	1 <sup>st</sup> issue	